

2004-2005 A Year in Review



The foundation for this 2004-2005 year in review combines technology and talent. The format of the traditional yearbook has undergone a complete change in every facet--from the colored pages, to the binding, to the cover--it's all a new endeavor. The accompanying DVD incorporates traditional coverage stories of the many AHS experiences and video clips that both utilize the diverse talents of the journalism staff. The staff would like to thank Katie Adams, Ciera Welch, Abbey Breinig, Donna Fisher, the *Arapahoe Public Mirror* Staff, sponsors, and coaches for their efforts in making this production a reality.

JOURNALISM STAFF: Angela Dawson, Kelsi Ervin, Kayla Hinz, Kody Metzger, and Heather Shelton. Advisors: Connie Hoefs and Pam Breinig.

Kindergarten



The Kindergarten Class includes Row 1 (l to r): Teacher Karen Custer, Brenden Conn, Brielle Weverka, Lanessa Kerner, Joseph Grindle, Robert Hastings, Jerry Ellis, Abraham Whitson, and Teacher's Aide Trudee Hamel. Row 2: Kimberly Anderson, Alexis Schievelbein, Derek Monie, Kenidee Miller, Noah Wadleigh, Robert Gardner, Alexis Horton, and Gabrielle Stephens. Not pictured: Faith Stapleton.

First Grade



The First Grade includes Row 1 (l to r) Teacher Lisa Schutz, Justin Warburton, Jacob Gardner, Mariah Jenkins, Ashton Wasenius, Shelby Kapperman, and Teacher Ann Collins. Row 2: Olivia Kort, Antoine Wendland, Jaci Hilker, Levi Watson, Amber Metzger, Morgan Curran, Jerome Rudolph. Row 3: Cooper Breinig, Austin Koller, Clare Anderson, Zachary Kerner, Mia Nevarez-King, Rebecca Gardner, and Danielle Eichenberger. Not pictured: Levi Fogel and Keenan Sailer.

Second Grade



Class
of 2015

The Second Grade includes Row 1 (l to r): Teacher Steff Stineman, Brandon Pruitt, Bailey Pruitt, Douglas Gordon, Cheyenne Stecklin, Daniel Bowers, Kaylee Warburton, Tyson Hemelstrand, and Teacher Sue Helms. Row 2: Taylor Jackman, Audrey Breinig, Kendra Simcox, Brennan Koller, Sheldon Cross, Jaclyn Stagemeyer, Kaylea Watson, and Macy Martinez. Row 3: Jordan Crosley, Tyrea Warner, London Scott, Ashley Groves, Zachary Wadleigh, Heather Eschen, Junior Hilker, and Janessa Arms. Not pictured: Katherine Besler, Collin Frink, Danniell Hardy, TJ Kelly, Bryce Leising, and Charity Stapleton.

Third Grade



Class
of 2014

The Third Grade includes Row 1 (l to r): Devin Hastings, Kendra Nitzel, Dustin Corrie, Shae Sughroue, Sabrina Gardner, Logan Warner, and Chandler Hearn. Row 2: Teacher Julie Stagemeyer, Emilee Franssen, Tyler Kipp, Sydney Henry, Jaylyn Juhl, Nathan Davis, Melissa Goodner, Kristina Schrock, and Teacher Shari Mues. Row 3: Brett Gardner, Garrett Monie, Aaron Hamel, Stephanie Paulsen, Brady DeVries, Caden Weverka, and Hannah Hanke. Row 4: Eric Vlasin, Kyla Monie, Garrett Rogers, Cheyanne Welch, Chandler Hambridge, Carley Polston, and Rochelle Wendland.



Fourth Grade



The Fourth Grade includes Row 1 (l to r): Alyssa Downey, Rebecca Stonerook, Halle Stephens, Isaac Watson, Alexa Whipple, and teacher Kate Hatch. Row 2: Fayth Walbridge, Paige Jenkins, Rylee Miller, Patrick Gardner, Hannah Helms, Jessica Moore, and Dakota Schroeder. Row 3: Ty Adams, Christen Williamson, Jared Crosley, Wyatt Anderson, Sarah Crawford, Gage Schutz, and Melinda Eichenberger. Not pictured: Sierra Hardy and Abigail Sailer.

Fifth Grade



The Fifth Grade includes Row 1 (l to r): Parker Novak, Stephanie Shearer, Wyatt Kipp, Paige Frink, and Kelsy Goodner. Row 2: Brianna Snyder, Jessica Jording, Justice Hastings, Rachel Koller, Cattarina Stock, Ryan Gardner, and Peggy Stonerook. Row 3: Alexandria Curran, Austin Hyke, Brooklyn Juhl, Reid Stagemeyer, Cassandra Yelton, Taylor Cross, and Ashley McCoy. Row 4: Justin Stagemeyer, Trev Hausler, Bradlee Loghry, Zachary Davis, Trisha Rogers, Andrea Leising, and Joel Stagemeyer. Not pictured: Josh Phipps.



Sixth Grade



The Sixth Grade Class includes Row 1 (l to r): Yooseon Baek, Jordan Edwards-Blow, Dustin Park, Nancy Stonerook, Amanda Loghry, Chelsea Stagemeyer, Maclane Scott. Row 2: Bradi Hilker, Alex Schultz, Heidi Mues, Max Walbridge, T.J. Eichenberger, Dakota Welch, Darrin Gordon, Garth Walbridge. Row 3: Amber Hampton, Kaitlyn tenBensel, Jennifer Grindle, Jennifer Highland, Kaylee Anderson, Megan Dawson, Caitlin Tangeman. Row 4: Kaycee Rogers, Nathan Leising, Danielle Schutz, Casie Campany, Scott Williamson, Makayla Wendland, Michele Borden, Cayla Polston, Thomas Adams. Not pictured: Shannon Sommer, Bailey Nicole Fogel.

Seventh Grade

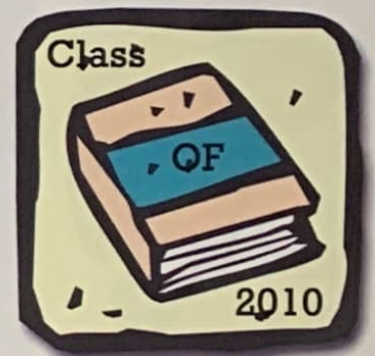

The Seventh Grade Class includes Row 1 (l to r): Killy Lampe, Dylan Ellis, Regan Koller, Cliff Stark, Jacob Bretton, Victoria Jackson, Cassandra Novak. Row 2: Trevor Jones, Jacuelyn Juhl, Grace Snyder, Bradly Goodner, Kendra Gardner, Tracia Park, Andrew Gardner. Row 3: Ian Thomas, Melissa Park, Alexandra Henry, Garrett Schutz, Derek Helms, Carmen Warner, Alaina Sughroue, Jason Hambidge. Not pictured: Micheal Stapleton.

Eighth Grade



The Eighth Grade Class includes Row 1 (l to r): Zachary Campany, Faith Hampton, Cecelia Stonerook, Hope Scott, Amelia Breinig, Brianna Kruger. Row 2: Grant Williamson, Yoojin Baek, Kayla Chambers, Catherine Paulsen, Cassandra Pulley, Dane tenBensel. Row 3: Rynanne Breinig, Jeremiah LaFore, Andy Wendland, Dillon Breinig, Ethan Jenkins, Dalton Hyke. Not pictured: Jessica Duran, Nichole Phipps, Channing Sailer, John Stapleton.

Freshmen



The Freshmen Class includes Row 1 (l to r): Lauren Warner, Erika Dawson, Samantha Jackson, Amanda Schutz, Jonathan Schutz. Row 2: Ashley Moore, Megan Wallgren, Jessica Stagemeyer, Crystal Highland, Cheryl Braithwait, Brittany Fanning. Row 3: Erica Karr, Justin Brooks, Adam Snyder, Adam Albertson, David Rohrer, Aaron McCoy. Row 4: Morgan Breinig, Brian Downey, Darrin Jones, Jordan Spaulding, Aaron Gillett, Dane Linden. Not pictured: Hawk Ellis, Robert Johansen.



Sophomores



The Sophomore Class includes: Row 1 (l to r): Megan Gardner, Amanda Huxoll, Zachary Henry, Tori Haussler, Jennie Clinton, Sarah Urbom, and Maggie Rudolph. Row 2: Alyssa Dickmeyer, Jessica Kent, Tobias Stonerook, Justin Robertson, Ryan Fricke, Jered Jenkins, and Garrett Tracy. Row 3: Jacob Titus, Kayla Goodner, Adam Borden, Tyler Hamel, Pierce Scott, James Dixon, and Drew tenBensel.

Juniors



The Junior Class includes: Row 1 (l to r): Tyler Brakhahn, Tiffany Moore, Lethea Gerard, Stephanie Leising, Lindsey DeVries, Katie Lampe, Hollie Thomas, Kayla Webb, and Julie Wendland. Row 2: Markie Sander, Justin Novak, David Blumenthal, Justin Schultz, Leslie Cookson, Alesa Paulsen, and Sarah Snyder. Row 3: Ciera Welch, Abbey Breinig, Kyle O'Brien, Joshua Beck, Tony Braithwait, Sebastian Edwards, and Shane Riley. Row 4: Blake Anderson, Norman Trautman, Kale Breinig, Tyson Moore, Dalton Helms, Ryan Stagemeyer, Blake Maaske, and Jonathan Stoye. Not pictured: Jessica Barber, Layta Gardner, and Evan Sailer.

Class of 2005



Katherine Diane
Adams



John Leslie
Baxter, Jr.



Michael Chase
Cacy



Angela Dawn
Dawson



Christopher Michel
DeOss



Theresia Evelyn
Dixon



Kelsi Lynn
Ervin



Brian Ray
Foster



Connie Marie
Heinen

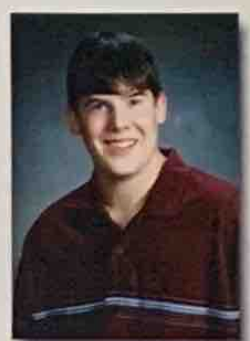

Cory Eugene
Helms



Kayla Jo
Hinz



Jennifer Dawn
Kreutzer

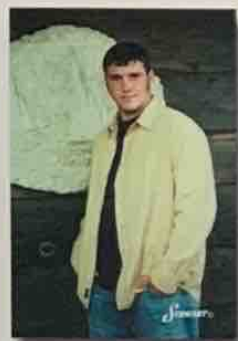

Kody Collin
Metzger



Phillip David
Mues



Jennifer Denise
Pierce



Stephanie
Pulley



Brandi Leigh
Rasmussen



Heather Laugarry
Shelton



Amber Nichole
Simmons



Jason Michael
Warner



Certified Staff



Certified Staff members include Row 1 (l to r): Marilyn Martin, Lisa Schutz, LeAndra Monie, Jeanne Paulsen, Shari Mues, April Overholser, Kate Hatch, and Pam Breinig. Row 2: John Paulsen, Steff Stineman, Chris Snyder, Shelly Edmundson, Geri Steinbrink, Senja Stephens, and Connie Hoefs. Row 3: Daren Hatch, Diane Scriptor, Sue Helms, Karen Custer, Nancy Breinig, Karen Windhusen, Judy Collins, Cinde Wendell, and Bob Braithwait. Row 4: Josh Hood, Kip Stephens, Colin Kubik, Chuck Collins, Julie Stagemeyer, Lynn Crosley, Rogene Wenburg, and Ann Collins. Not pictured: Raime Varvel, Anita Kredjl, and Janie Hilker.

Support Staff



Support Staff members include Row 1 (l to r): Linda Anderson, Kelly Breinig, Beverly Huxoll, and Erma Pfeiffer. Row 2: Cheryl Chambers, Teresa Park, Charles Pruitt, Shelia Pruitt, Chuck Huxoll, Bruce Sander, Sara Stonerook, Roella Dougherty, Donna Fisher, Margie Gardner, and Cindy Huxoll. Not pictured: Judy Beedle, Cindy Bowers, Jim Crosley, Joetta Glanzer, Shelly Goodner, Trudee Hamel, Deb Helms, Patricia Riley, Thersa Shearer, and Amy Watson.



Warrior Volleyball



The 2004 AHS Volleyball Team includes Row 1 (l to r): Regan Koller, Julie Wendland, Amanda Schutz, Crystal Highland, Cheryl Braithwait, Sarah Urbom, Brittany Fanning, Lauren Warner, Samantha Jackson, Hollie Thomas, Stephanie Leising. Row 2: Coach Lisa Schutz, Carmen Warner, Amy Breinig, Ashley Moore, Jessica Stagemeyer, Morgan Breinig, Abbey Breinig, Alesa Paulsen, Angela Dawson, Lindsey DeVries, Kayla Hinz, Kelsi Ervin, Cathy Paulsen, Grace Snyder, and Coach Kasey Warner.



Angela Dawson passes the ball as Kayla Hinz and Abbey Breinig move in to cover the play.



Kelsi Ervin sets the ball while fellow Warriors Cheryl Braithwait, Abbey Breinig, and Sarah Urbom prepare to attack.



The team meets on the floor for the pre-game ritual.



Angela, Kayla, Kelsi

Scoreboard		
AHS		OPP
2	Hitchcock Co.	1
0	Dundy County	2
0	Alma	3
0	Axtell	3
0	Wheatland	2
1	Hayes Center	2
0	Alma	2
0	Cozad	2
1	Bertrand	3
1	Hitchcock Co.	2
0	Cambridge	2
0	North Platte St. Pat's	2
0	Medicine Valley	2
0	Alma	3
1	Elwood	3
1	Wilcox-Hildreth	2
0	Superior	2
2	Bertrand	1
0	Elm Creek	2
2	Cambridge	1
3	Hitchcock Co.	0
1	Eustis-Farnam	3

Warrior Football



The 2004 AHS Gridmen include Row 1 (l to r) Leslie Cookson, Cory Helms, Jason Warner, Michael Cacy, Ryan Stagemeyer, Blake Maaske, Kody Metzger, Dalton Helms, Brian Foster. Row 2: Jered Jenkins, Joshua Beck, Kale Breinig, Justin Schultz, Adam Borden, Blake Anderson, Tyler Hamel, Pierce Scott, Tony Braithwait. Row 3: John Baxter, Aaron Gillett, Jordan Spaulding, Adam Snyder, Justin Brooks, Ryan Fricke, Aaron McCoy, Tobias Stonerook. Row 4: Jonathan Schutz, Sebastian Edwards, Brian Downey, Drew tenBensel, Kyle O'Brien, Tyson Moore, Michel DeOss. Row 5: Coaches Josh Hood, Daren Hatch, John Paulsen.



Michael Cacy catches a touch-down pass during the first round of State Play-Offs against the Maxwell Wildcats.



Kody Metzger goes for a tackle against an Elwood Pirate during the D1-9 District Championship game.

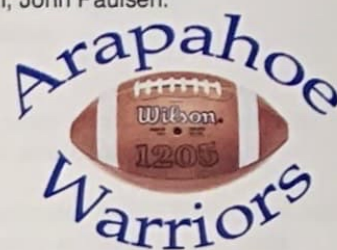

The Warriors' defensive line consisting of John Baxter, Dalton Helms, and Kody Metzger prepare to stop the Maxwell Wildcats from getting a first down in the first round of state playoffs.

Scoreboard

AHS		OPP
52	Alma	6
40	Dundy Co.	14
42	Wauneta-Palisade	28
44	Anselmo-Merna	16
56	Eustis-Farnam	6
56	Callaway	6
26	Elwood	6
50	Maxwell	0
56	Maxwell	6
30	Elm Creek	28
14	Overton	58

Lady Warrior Basketball



The 2004-2005 Lady Warrior Basketball Team includes Row 1 (l to r): Lindsey DeVries, Brittany Fanning, Stephanie Leising, and Jessica Stagemeyer. Row 2: Julie Wendland, Cheryl Braithwait, Sarah Urbom, Jennie Clinton, Hollie Thomas, and Ashley Moore. Row 3: Coach Kip Stephens, Kelsi Ervin, Morgan Breinig, Alesa Paulsen, Abbey Breinig, Angela Dawson, Kayla Hinz, Jennifer Kreutzer, and Coach Amy Watson.



Left: AHS junior Hollie Thomas dribbles around two defenders against Loomis.

Right: Teammates Abbey Breinig and Jennifer Kreutzer watch as Sarah Urbom goes in for the layup.



Varsity Basketball girls reign as champions of the McCook Cattle Trail Cartel Tournament. Row 1 (l to r): Morgan Breinig, Lindsey DeVries, Brittany Fanning, and Hollie Thomas. Row 2: Cheryl Braithwait, Sarah Urbom, and Jennie Clinton. Row 3: Kayla Hinz, Angela Dawson, Abbey Breinig, Alesa Paulsen, and Kelsi Ervin.



Seniors to lead the team this year include row 1 (l to r): Jennifer Kreutzer, and Angela Dawson. Row 2: Kelsi Ervin and Kayla Hinz.

Scoreboard

AHS		OPP
53	Wauneta-Palisade	73
48	Overton	43
51	Grinnell	43
54	Hitchcock Co.	36
53	Hayes Center	44
31	Southwest	56
62	Nemaha Valley	46
45	Red Cloud	30
54	Medicine Valley	53
45	Loomis	67
63	Elwood	54
47	Dundy Co.	32
48	Alma	33
51	Southern Valley	76
51	Eustis-Farnam	49
31	Alma	33
42	Cambridge	64
61	Hitchcock Co.	43
32	Bertrand	49
62	Hitchcock Co.	35
28	Eustis-Farnam	49



Angela, Kayla, Kelsi

Warrior Basketball

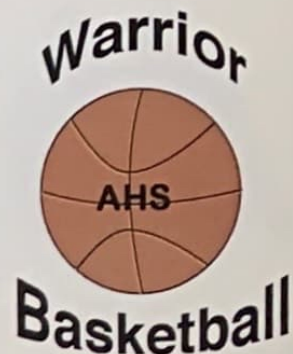

The 2004-2005 Warrior Basketball Team includes Row 1 (l to r): Zach Henry, Aaron McCoy, Adam Snyder, Ryan Fricke, Adam Borden, Justin Schultz. Row 2: Michael Cacy, Evan Sailer, Pierce Scott, Tony Braithwait, Jason Warner, Justin Brooks, and Tyler Hamel. Row 3: Coach Bob Braithwait, Joshua Beck, Blake Anderson, Jordan Spaulding, Blake Maaske, Ryan Stagemeyer, Coach Colin Kubik, and Coach Josh Hood.



LEFT: Jason Warner and Michael Cacy are the lone senior team members.

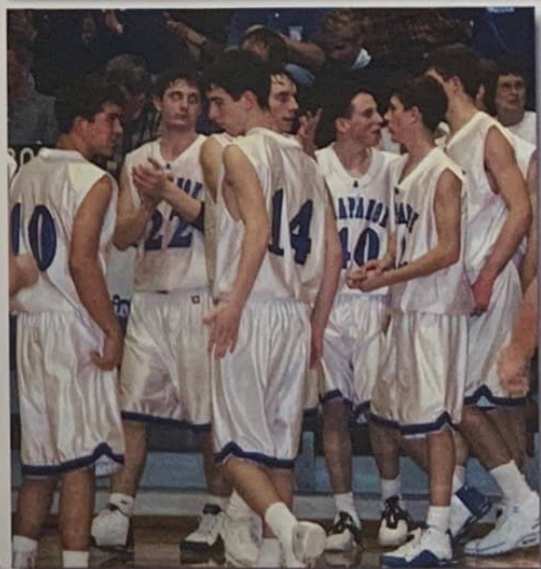

LEFT: Team members engage in a huddle to discuss plays.

AHS	Scoreboard	OPP
59	Wauneta-Palisade	61
56	Overton	41
67	Maywood	45
71	Hitchcock Co.	40
59	Southwest	48
44	Southwest	41
75	Nemaha Valley	49
54	Pleasanton	62
58	Medicine Valley	30
70	Loomis	66
67	Elwood	49
55	Dundy Co.	39
51	Southern Valley	42
61	Eustis-Farnam	34
66	Bertrand	35
42	Southern Valley	54
72	Cambridge	65
68	Hitchcock Co.	38
2	Northern Valley, KS.	0
90	Bertrand	49
59	Alma	35
79	Medicine Valley	49
66	Cambridge	73

WAR
HOOPS

Warrior Wrestling



The 2004-2005 Warrior Wrestling Team includes Row 1 (l to r): Leslie Cookson, Tobias Stonerook, Jered Jenkins, Sebastian Edwards, Hawk Ellis, and student manager Dane tenBensel. Row 2: Coach Daren Hatch, John Baxter, Dalton Helms, Drew tenBensel, Norman Trautman, Phillip Mues, Aaron Gillett, and student manager Ethan Jenkins.



State qualifiers Sebastian Edwards Jered Jenkins, and John Baxter begin to focus on the state meet in Lincoln.

<u>Team Finishes at Invitationals</u>	
Elwood Invite	8th
Southern Valley	8th
Amherst Invite	5th
Shelton Invite	5th
RVL	7th
Arapahoe Invite	7th
Loup City Invite	6th
<u>State Qualifiers</u>	6th
<i>Jered Jenkins</i>	
<i>Sebastian Edwards</i>	
<i>John Baxter</i>	

WARNING

AHS Wrestlers . . .
Proceed at your own risk.



Boys' Track

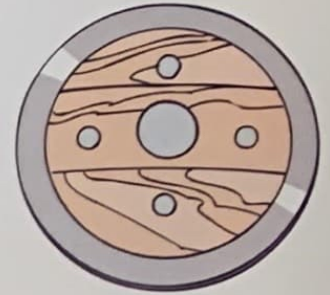

The Boys' Track Team includes Row 1 (l to r): Blake Maaske, Adam Snyder, Leslie Cookson, Adam Borden, Aaron McCoy, Jered Jenkins, Ryan Fricke, and Dane Linden. Row 2: Aaron Gillett, Phillip Mues, Michael Cacy, Tony Braithwait, Drew tenBensel, Joshua Beck, Evan Sailer, and Pierce Scott. Row 3: Justin Brooks, Blake Anderson, Kody Metzger, Tyson Moore, Ryan Stagemeyer, Dalton Helms, Jordan Spaulding, Tyler Hamel, and Kale Breinig.

Girls' Track

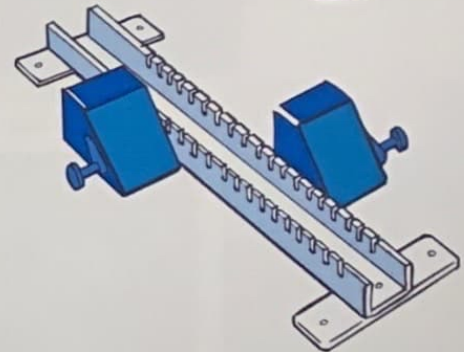

The Girls' Track Team includes Row 1 (l to r): Lindsey DeVries, Abbey Breinig, Alesa Paulsen, and Morgan Breinig. Row 2: Cheryl Braithwait, Sarah Urbom, Jennie Clinton, and Jessica Stagemeyer. Row 3: Ashley Moore, Samantha Jackson, and Maggie Rudolph.



Warrior Golf



The 2004 AHS Golf Team includes (l to r): Coach Steven Koller, Sebastian Edwards, Michel DeOss, Kyle O'Brien, Brian Downey, Brittany Fanning, Cory Helms, Jonathan Stoye, David Rohrer. Not pictured: Katie Lampe.



Cory Helms watches as he hits his ball.



Kyle O'Brien putts the ball.



Michel DeOss practices his golf swing.



Brittany Fanning lines up her ball to get a perfect putt.



Sebastian Edwards follows his ball as it flies through the air.



Jonathan Stoye makes sure he has a full swing through.



Cheerleading



Cheerleaders are Row 1 (l to r): Hollie Thomas, Brittany Fanning, Julie Wendland, and Markie Sander. Row 2: Jennie Clinton, Katie Lampe, Angela Dawson, and Kayla Webb.



Relief is clear after the girls finish their successful pep rally dance.



The squad takes a break from the cold during Elwood football game.



Several members of the squad clap to the beat during a crowd cheer.



The cheerleaders pump up the crowd at the Homecoming pep rally in the park.



The squad performs a routine before finals at the Arapahoe Wrestling Invite.



Angela Dawson prepares to flip Katie Lampe over her back during a dance.



Band



The Band includes Row 1 (l to r): Katie Adams, Lindsey DeVries, Hollie Thomas, Jessica Kent, Erika Dawson, Samantha Jackson. Row 2: Stephanie Leising, Amanda Schutz, Kayla Goodner, Zach Henry, Tyson Moore, Brandi Rasmussen, David Rohrer, Tori Haussler, Alyssa Dickmeyer, and Aaron Gillett, Row 3: Joshua Beck, Sarah Snyder, Julie Wendland, Brittany Fanning, Sarah Urborn, Aaron McCoy, Abbey Breinig, Drew tenBensel, Adam Snyder, Ryan Fricke, Justin Robertson, and Garrett Tracy. Row 4: Phillip Mues, Director Raime Varvel, and Michael Cacy.



ABOVE: The Flag Team includes (l to r) Lindsey DeVries, Katie Adams, Maggie Rudolph, Jessica Kent, and Amanda Schutz.

LEFT: The senior band members are Row 1: Katie Adams, and Brandi Rasmussen. Row 2: Phillip Mues, and Michael Cacy.



Vocal



The Vocal Class includes Row 1 (l to r): Lindsey DeVries, Amanda Huxoll, Tiffany Moore, Megan Gardner, Erika Dawson, Aaron McCoy, Tobias Stonerook, Zach Henry, Evan Sailer, Tori Haussler, Morgan Breinig, Cheryl Braithwait, and Tyler Brahkahn. Row 2: Theresia Dixon, Alyssa Dickmeyer, Layta Gardner, Heather Shelton, Brandi Rasmussen, Jessica Stagemeyer, Sebastian Edwards, Brian Downey, Garrett Tracy, Adam Borden, Kyle O'Brien, Adam Albertson, Samantha Jackson, Megan Wallgren, and Lauren Warner. Row 3: Jessica Kent, Stephanie Pulley, Alesa Paulsen, Kelsi Ervin, Jennifer Kreutzer, Phillip Mues, Leslie Cookson, Jonathan Stoye, Joshua Beck, Kale Breinig, Ashley Moore, Sarah Snyder, Jennie Clinton, Sarah Urbom, and Director Senja Stephens. Row 4: Amber Simmons, Connie Heinen, Kayla Webb, Brittany Fanning, Kayla Goodner, Michael Cacy, Tony Braithwait, Blake Maaske, Blake Anderson, Ryan Stagemeyer, Jordan Spaulding, Markie Sander, Angela Dawson, and Kayla Hinz.



The senior vocal members are Row 1: Angela Dawson and Heather Shelton. Row 2: Kelsi Ervin, Theresia Dixon, and Brandi Rasmussen. Row 3: Stephanie Pulley, Connie Heinen, Jennifer Kreutzer, and Kayla Hinz. Row 4: Michael Cacy, Amber Simmons, and Phillip Mues.



Providing the sounds of the holiday season are (clockwise from top left): Abbey Breinig, Markie Sander, Ashley Moore, Megan Wallgren, Lauren Warner, Jennie Clinton, and Tori Haussler.

Musical



Part of the *Guys and Dolls* cast performs on stage. These members include Row 1 (l to r): Aaron McCoy, Michael Cacy, Kale Breinig. Row 2: Zach Henry, Tobias Stonerook, Sebastian Edwards, Ryan Stagemeyer, Adam Borden, Tony Braithwait.



Sky Masterson catches Sister Sarah's drunken fall.



Nathan Detroit and Adelaid fall in love.



The Dolls dance behind Adelaid while singing "Take Back Your Mink." Row 1: Kayla Webb. Row 2 (l to r): Angela Dawson, Kelsi Ervin, Markie Sander, Alesa Paulsen, Morgan Breinig, Brittany Fanning, Jessica Stagemeyer, Alyssa Dickmeyer, Jessica Kent.



One Act



The 2004 AHS One Act Team includes Row 1 (l to r): Sarah Snyder, Mandy Huxoll. Row 2: Alesa Paulsen, Abbey Breinig.

Speech Team



The 2004-2005 AHS Speech Team members include Row 1 (l to r): Joshua Beck, Michael Cacy, Jason Warner, Lauren Warner. Row 2: Tobias Stonerook, Sarah Snyder, Kayla Webb, Tori Haussler, Amanda Schutz, Katie Adams, Zach Henry. Row 3: David Rohrer, Jacob Titus, Coach Raime Varvel, and Theresia Dixon.

FCCLA



The 2004-2005 FCCLA Chapter members include Row 1 (l to r): Killy Lampe, Victoria Jackson, Ryanne Breinig, Jacuelyn Juhl, Cecelia Stonerook, Tracia Park, and Faith Hampton. Row 2: Bradley Goodner, Megan Gardner, Tori Haussler, Lindsey DeVries, Katie Adams, Amanda Huxoll, Stephanie Leising, Crystal Highland, and Jonathan Schutz. Row 3: Sponsor Marilyn Martin, Brandi Rasmussen, Justin Brooks, Kayla Goodner, Jessica Kent, Amber Simmons, Stephanie Pulley, Alyssa Dickmeyer, and Cassie Pulley.



The 2004-2005 FCCLA officers include (l to r): Lindsey DeVries as Secretary/Treasurer, Brandi Rasmussen as Vice President, Katie Adams as President, Stephanie Leising as Vice President of Programs and Alyssa Dickmeyer as Publicity Historian.



These members were involved in a project for National Programs in Action, (l to r): Brandi Rasmussen, Lindsey DeVries, and Katie Adams.



Katie Adams and Lindsey DeVries organize the clothing made for a service project.

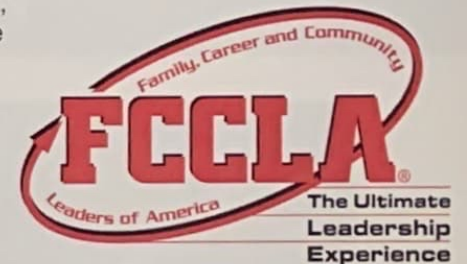

LEFT: FCCLA members made the Veterans' Day Program a success. Tori Haussler recites a poem that a student had written for the special occasion.



Student FFA Council



The 2004-2005 FFA Chapter includes Row 1 (l to r): Dalton Helms (Sentinel), Justin Schultz (Secretary), Cory Helms (Vice President), Jason Warner (President), Shane Riley (Treasurer), Abbey Breinig (News Reporter), and Tyler Hamel (Parliamentarian). Row 2: John Baxter, Adam Borden, Drew tenBensel, Ryan Fricke, Kayla Chambers, and Kayla Goodner. Row 3: James Dixon, Sarah Urborn, Jennie Clinton, Morgan Breinig, Amanda Schutz, Lauren Warner, and Jared Jenkins. Row 4: Theresia Dixon, Amy Breinig, Dane tenBensel, Dillon Breinig, Blake Anderson and Advisor Colin Kubik.



LEFT: Jason Warner carefully evaluates the grasses at a land judging contest. LOWER LEFT: Several FFA members make plans to harvest the test plot. RIGHT: Justin Schultz, Jason Warner, Shane Riley and Dalton Helms earned a top finish at the State FFA Convention. LOWER RIGHT: Jason Warner and Advisor Colin Kubik man the podium while Cory Helms (seated) and Shane Riley look on.



Student Council



The Student Council members include Row 1 (l to r): Drew tenBensel, Brandi Rasmussen, Heather Shelton, Alesa Paulsen, Sarah Urbom, and Cheryl Braithwait. Row 2: Jason Warner, Angela Dawson, Katie Adams, Aaron McCoy, and Kayla Goodner. Row 3: Tony Braithwait, Adam Snyder, Michael Cacy, Cory Helms, and Jordan Spaulding.

National Honor Society



The National Honor Society includes (l to r): Joshua Beck, Shane Riley, Kale Breinig, Justin Schultz, Dalton Helms, Jason Warner, Tony Braithwait, Hollie Thomas, Ryan Stagemeyer, Alesa Paulsen, Angela Dawson, Abbey Breinig, Katie Adams, Maggie Rudolph, Lindsey DeVries, Ciera Welch, Sarah Snyder, and Julie Wendland.



Outstanding Students



Future Problem Solvers



The Future Problem Solvers include (l to r): Jessica Kent, Alyssa Dickmeyer, Coach Chuck Collins, Jacob Titus, Tobias Stonerook, Coach Sara Stonerook, Amanda Huxoll and Cecelia Stonerook.



Quiz Bowl



The Arapahoe Quiz Bowl includes (l to r): Zach Henry, Sarah Snyder, Kale Breinig, Alyssa Dickmeyer, Joshua Beck, Tori Haussler, Tony Braithwait, and Amanda Schutz. Not pictured: Abbey Breinig and Adam Snyder.

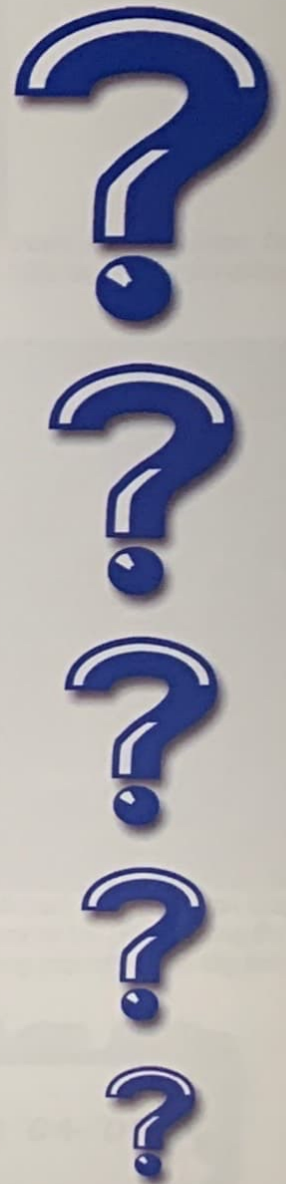

Homecoming



The 2004-2005 Homecoming Royalty includes Row 1 (l to r): Crown Bearer Gabby Stephens, Princess Angela Dawson, Queen Heather Shelton, King Jason Warner, Prince Michael Cacy, Crown Bearer Abe Whitson. Row 2: 2003 Queen Sarah Hardenbrook, Kody Metzger, Katie Adams, Kelsi Ervin, Cory Helms, and 2003 King Pat Nott.



LEFT: Jason Hambridge, Kayla Chambers, Alyssa Dickmeyer, Garrett Tracy, and David Rohrer.

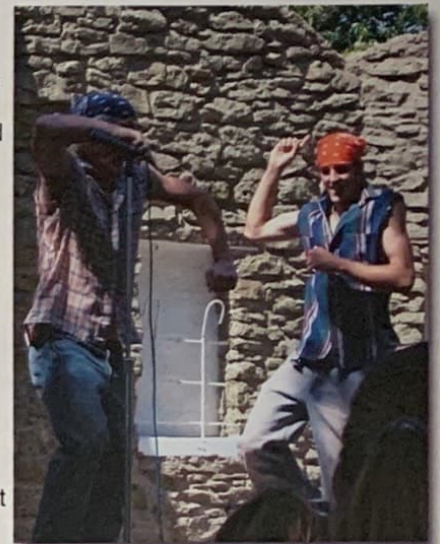

ABOVE: Michael Cacy and Ryan Stage-meyer dance for the crowd during the Homecoming pep rally at the city park.



LEFT: Kelsi Ervin and Kody Metzger, Homecoming Royalty, wave at the crowd during the parade downtown.



Prom



Jennie Clinton, Sarah Urborn, Julie Wendland, Cheryl Braithwait, and Hollie Thomas wait patiently for their dinner.



Tony Braithwait and Ryan Stagemeyer hang up the soda fountain sign as Jessica Barber assists them.



Dalton Helms stands proudly in front of the record clock that he made.



The 2004-2005 Prom Servers Row 1 (l to r): Zach Henry, and Tobias Stonerook. Row 2: Alyssa Dickmeyer, Tori Haussler, Kayla Goodner, and Maggie Rudolph.



These junior girls take time out of their busy day of decorating to pose for a picture. (l to r): Markie Sander, Kayla Webb, Julie Wendland, Hollie Thomas, Ciera Welch, Sarah Snyder, Katie Lampe, Lethea Gerard, and Abbey Breinig.



The 2004-2005 Prom Candidates (l to r): Michael Cacy, Kelsi Ervin, King Cory Helms, Queen Angela Dawson, Kody Metzger, and Katie Adams.



Graduation



The 2004-2005 Graduating class includes Row 1 (l to r): Katie Adams, Brandi Rasmussen, Stephanie Pulley, Jennifer Kreutzer, Jennifer Pierce, and Amber Simmons. Row 2: Heather Shelton, Theresia Dixon, Connie Heinen, Kelsi Ervin, Angela Dawson, Kayla Hinz, and Phillip Mues. Row 3: John Baxter, Michel DeOss, Brian Foster, Kody Metzger, Michael Cacy, Jason Warner, and Cory Helms.



Seniors celebrate in style.



Salutatorian Jason Warner
Valedictorian Katie Adams



Kody Metzgers pauses for a photo with Heather Shelton, Kelsi Ervin, Angela Dawson, and Kayla Hinz.



Kelsi Ervin and Jennifer Kreutzer pose for a picture as they wait for the ceremony to begin.



Heather Shelton

